

ASSEMBLY INSTRUCTIONS

DVP44001
DVP44099

Warning

All electrical connections must be made according to local codes. If you feel you do not have the experience necessary to do this, please have your fixture installed by a qualified, licensed electrician.

Make sure to note the maximum recommended wattage for your light fixture.
DO NOT EXCEED THE RECOMMENDED WATTAGE:

DVP44001 - 1 x 25W Candelabra
DVP44099 - 2 x 25W Candelabra

Cleaning

We recommend that you use a mild detergent, such as dish washing soap, and warm water to clean the glass and metal surfaces. After cleaning, make sure to dry the fixture completely because moisture will corrode the satin finish. Use a damp soft cloth to wipe off dust. DO NOT use abrasive pads or cleaning materials.

During installation, some fixtures may require subtle adjustments in order for the fixture to look as intended.

Tools

Phillips head screwdriver
Allen key

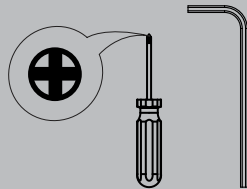

If you have any questions, comments, or concerns contact us at customerservice@dvi.lighting

DVI Lighting
120 Great Gulf Drive, Concord
Ontario, L4K 5W1 Canada
T: 1 855 384 5483
F: 1 855 384 8435



1

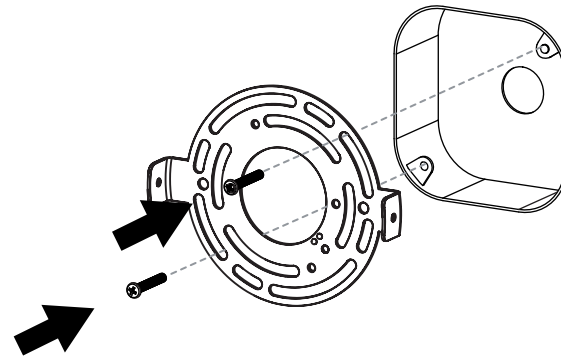

2

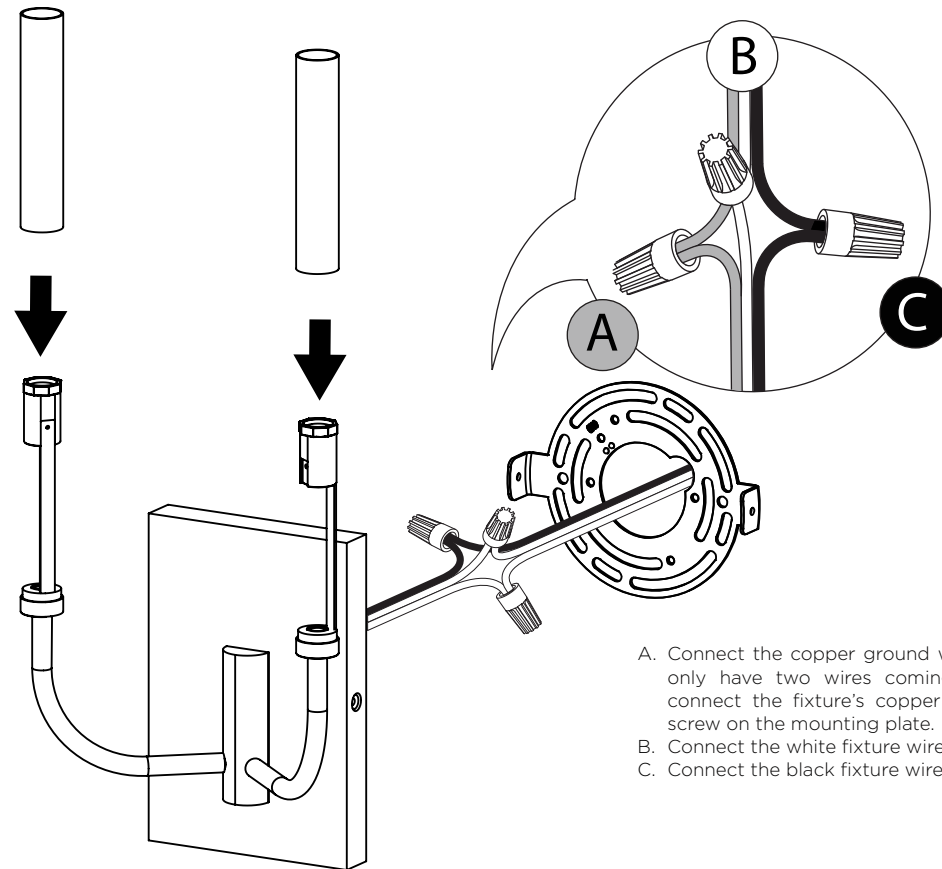

- A. Connect the copper ground wire to ground wire - If you only have two wires coming from the electrical box, connect the fixture's copper wire to the green ground screw on the mounting plate.
- B. Connect the white fixture wire to white supply wire.
- C. Connect the black fixture wire to black supply wire.

These instructions are property of DVI Lighting. Do not copy or reproduce.

3

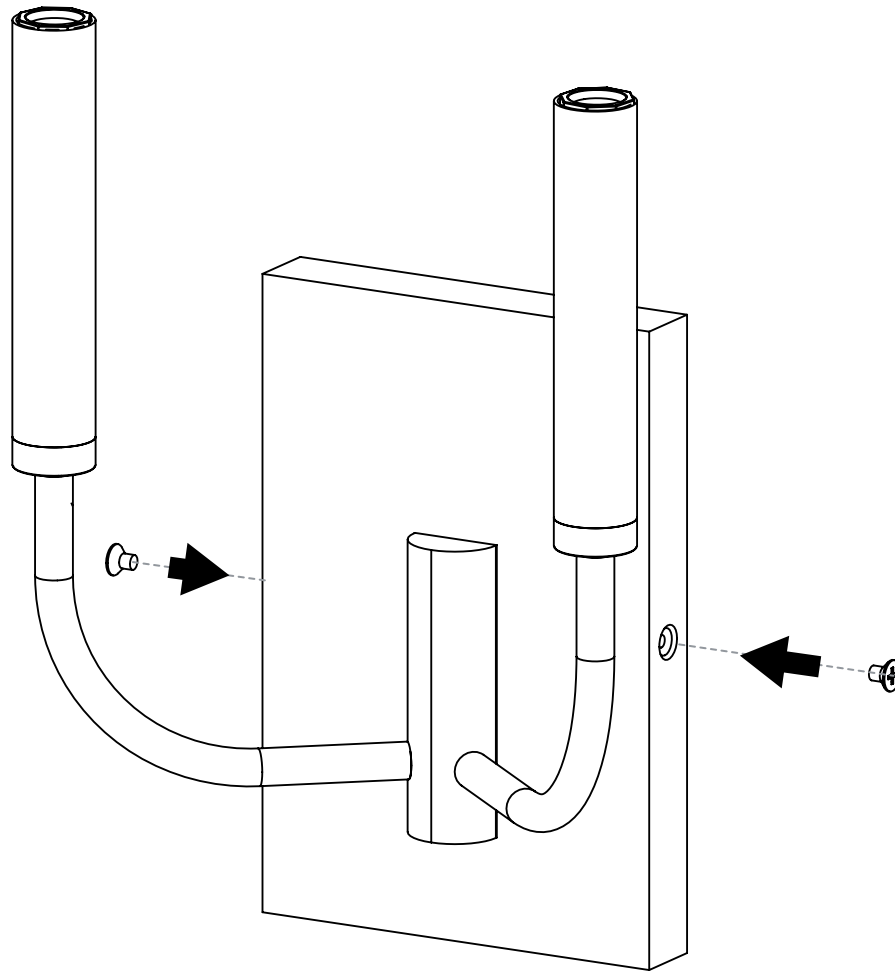

**RENOVATING
YOUR HOME?**

Snap a photo of your fixture in your home and tag us on our social media for your chance to be featured!

These instructions are property of DVI Lighting. Do not copy or reproduce.

FOLLOW US:

 facebook.com/dvilighting

 @dvi.lighting

 @dvilighting

 pinterest.com/dvilighting

 www.dvi.lighting

PLAN DE MONTAGE

DVP44001
DVP44099

Avertissement

Risque d'incendie et de choc électrique. Ce produit doit être installé par un electricien qualifié et certifié. Votre filerie doit être conforme aux codes locaux et nationaux. Si vous n'avez que deux fils dans votre boîte électrique, vissez le fil en cuivre sur la barre transversale de l'appareil.

NE PAS EXCÉDER LE WATTAGE RECOMMANDÉ:

DVP44001 - 1 x 25W Candélabre
DVP44099 - 2 x 25W Candélabre

Nettoyage

Épousseter, pour nettoyer le verre à fond, laver à la main avec un savon doux et assécher immédiatement pour retenir le fini satiné. N'utilisez pas de produits abrasifs ou chimiques.

Instruments

Tournevis Phillips
Clef Allen

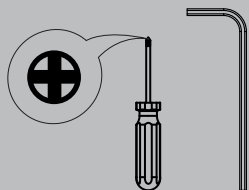

Pour toutes questions ou commentaires veuillez nous contacter au customer.service@dvi.lighting

DVI Lighting
120 Great Gulf Drive, Concord
Ontario, L4K 5W1 Canada
T: 1 855 384 5483
F: 1 855 384 8435



1

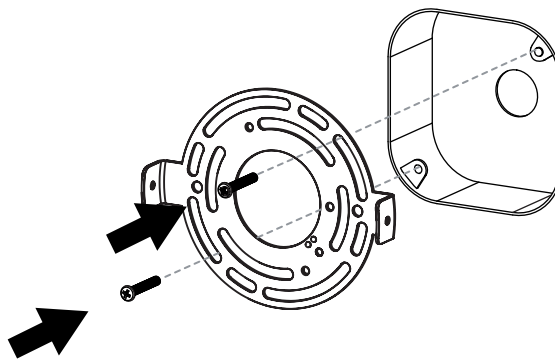

2

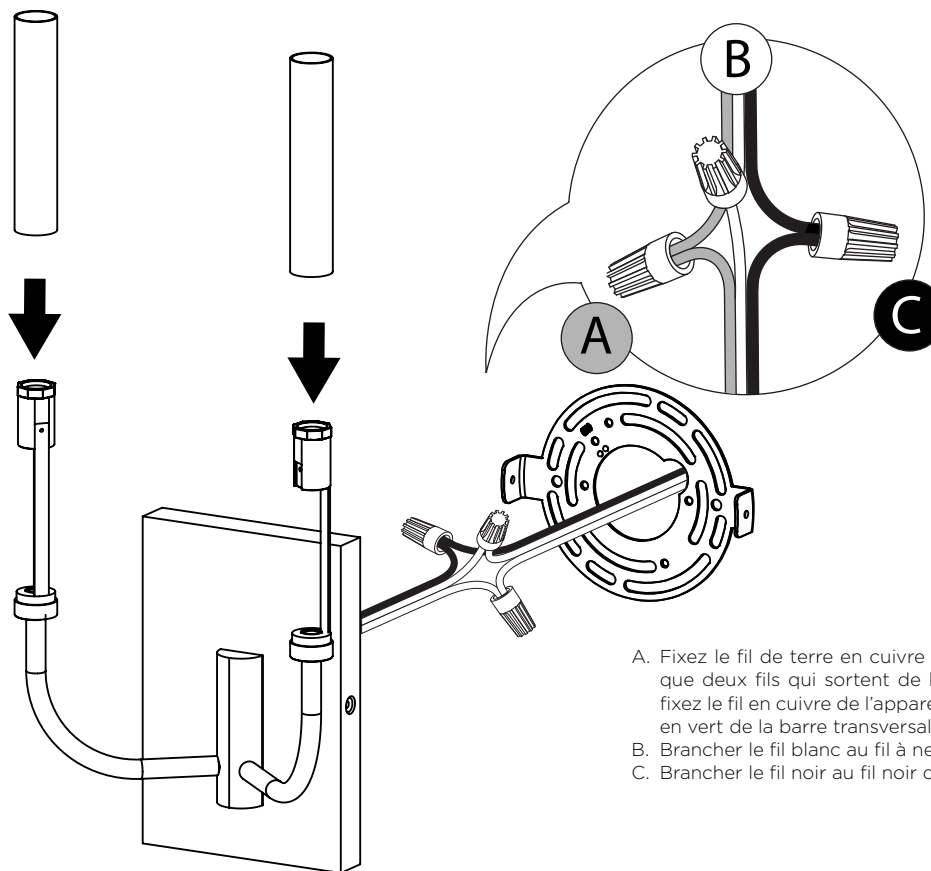

- A. Fixez le fil de terre en cuivre à la mise à la terre. S'il n'y a que deux fils qui sortent de la boîte de sortie électrique, fixez le fil en cuivre de l'appareil d'éclairage à la vis de terre en vert de la barre transversale.
- B. Brancher le fil blanc au fil à nervures(neutre) du luminaire.
- C. Brancher le fil noir au fil noir du luminaire.

Ces instructions sont la propriété de DVI éclairage. Ne pas copier ou de reproduire.

3

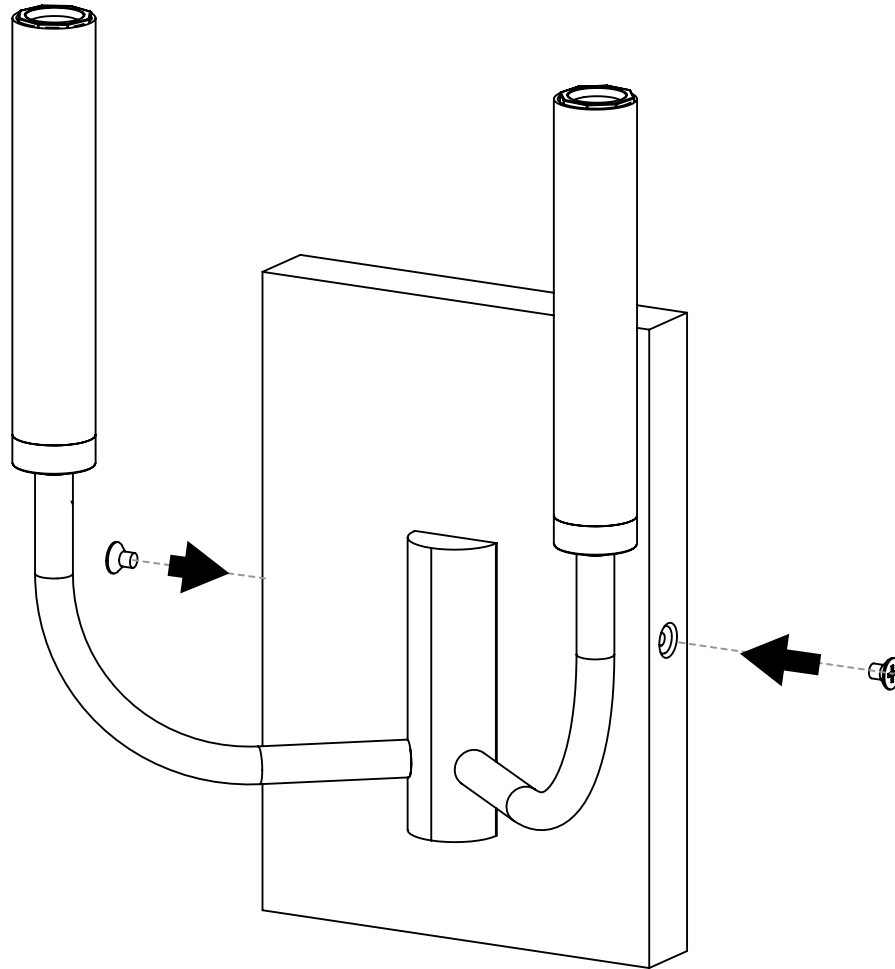

**FIER DE VOS
RÉNOVATIONS?**

Prenez une photo de
votre pièce avec ce
luminaire et identifiez-
nous pour courrir la
chance qu'on la
partage!

Ces instructions sont la propriété de DVI éclairage. Ne pas copier ou de reproduire.